

/ Perfect Welding / Solar Energy / Perfect Charging



SHIFTING THE LIMITS



# WHITEPAPER ON OFFGRID AND BACKUP SYSTEMS

**Fronius Microgrid Solution**

**Fronius PV-Genset Solution**



© Fronius International GmbH

Version 1.0/2014

Solar Energy

Fronius reserves all rights, in particular rights of reproduction, distribution and translation.

No part of this work may be reproduced in any way without the written consent of Fronius. It must not be saved, edited, reproduced or distributed using any electrical or electronic system.

You are hereby reminded that the information published in this document, despite exercising the greatest of care in its preparation, is subject to change and that neither the author nor Fronius can accept any legal liability.

Gender-specific wording refers equally to female and male form.

.

# TABLE OF CONTENTS

<b>1</b>	<b>Introduction .....</b>	<b>4</b>
<b>2</b>	<b>Inverter-Charger driven microgrids .....</b>	<b>5</b>
2.1	AC-coupling .....	6
2.1.1	Basic Inverter-Charger AC-coupling .....	7
2.1.2	AC-coupling as grid back-up.....	7
2.1.3	Optimising Microgrids / Extended Inverter-Charger AC-coupling.....	7
2.2	Fronius Microgrid Solution .....	8
<b>3</b>	<b>Operation of PV-Genset Systems .....</b>	<b>10</b>
3.1	Fronius PV-Genset Solution .....	12
3.1.1	Protecting and optimizing the diesel genset .....	13
3.1.2	Optimising the PV-Genset system.....	13
3.1.3	Online system monitoring .....	14
3.1.4	Products for the Fronius PV-Genset Solution.....	14
<b>4</b>	<b>Appendix: Inverter features supporting microgrids .....</b>	<b>15</b>
4.1	Gradual Frequency dependent Power Reduction (GFdPR) .....	15
4.2	Gradual Voltage dependent Power Reduction (GVdPR).....	16
4.3	Reactive Power as a function of Voltage (Volt-VAR-curve).....	16

# 1 INTRODUCTION

Photovoltaics (PV) are continually gaining the focus of microgrid (MG) operators. In the fast growing sector of MGs, PV and wind power are currently providing the best and cost effective solutions, in comparison to traditional fossil fuel resources like diesel, oil, coal, etc. Annual costs of PV systems have been decreasing, and when compared to the increasing costs of traditional fossil fuels and their transportation aspects, the very positive market for solar business becomes subtle.

A MG is an energy system comprising of distributed generators, consumers and storage facilities. These distributed generators can not only be fuelled by fossil energy resources (diesel, gas, etc.), but also by renewables (biogas, PV, fuel cells, etc.). MGs can be established in areas with weak security of energy supply and in remote rural communities or industrial areas. Generally, MGs are able to work in parallel to an existing power grid (“on-grid-mode”), in addition to the islanding mode (“off-grid-mode”). The main focus of this document lies on the “off-grid” behavior, in case of such MGs. Diesel generator sets in MGs are able to build a stable grid (voltage, frequency) within limited areas offering a unique advantage that the site of power generation is located in the vicinity of loads. MGs act like little self-sustaining cells where the demand and generation are in equilibrium. The lack of long distance distribution networks makes the energy supply through these grids even more valuable, since the distribution losses become minimal.

We classified the MGs into two types:

- / Inverter-Charger driving small and medium scale MGs (up to 300 kVA) with or without a backup AC source (diesel genset or AC backup grid)  
**Fronius Microgrid Solution**
- / Diesel Genset driven medium and large scale MGs (100 kVA up to MVA)  
**Fronius PV-Genset Solution**

MGs formed by Inverter/Chargers are usually smaller than dieselgrids<sup>1</sup> (<300kVA), and are used to power commercial buildings or smaller settlements in remote locations.

“Dieselgrids” are rather large, and are located in areas, where it is economically or technically difficult to build the transmission lines. They are popular in countries with variations in its geographical demography (resulting in a number of remote locations, for e.g. Australia), and in countries with a weak security of energy supply, for e.g. regions of India and the Asia/Pacific, in general. The size of such MGs can be of several 100s kVA.

---

<sup>1</sup> MGs mainly powered by diesel gensets

## 2 INVERTER-CHARGER DRIVEN MICROGRIDS

Inverter-Charger driven MGs usually consist of three main components. The Inverter-Charger itself, a battery bank to store/provide the electricity required, and an external power source (back-up AC-grid, back-up diesel, renewables) to facilitate the recharging of batteries.

It is important to know that the Inverter-Charger is in charge of keeping the system in balance (i.e. active and reactive power), in addition to performing all energy management related tasks (for e.g. UPS<sup>2</sup>, turn-on/turn-offs, back-up diesel sets, etc.).

Since the Inverter-Charger must be able to meet the demands of the load, its nominal power must be dimensioned above the expected peak load. It is usually possible for the Inverter-Charger to sustain supply of extra power (exceeding the nameplate's rating) for short durations (i.e., up to several seconds), which might be essential in case of inrush currents or to trip the protection devices – in case of issues addressing the safety aspects.

Sizing the battery is important, since they are the main and price driving factor of such systems.

The maximum achievable system-size largely depends on user's choice of type of Inverter-Charger. Usually, several units per phase can be connected in parallel (two up to ten) depending on the manufacturer and type. Therefore, the maximum 3 phase system size is limited, for e.g. 63 kVA or up to 300 kVA. For single phase systems 21 kVA / 100 kVA is also a possibility.

The integration of renewables like PV into such systems can be achieved either by employing Maximum Power Point Tracking (MPPT) charge controllers on the 12 ... 48 V<sub>DC</sub> bus which is typically called as "DC-coupling", or through the use of conventional grid-tied inverters that feeds-in on the AC Bus, which is termed as "AC-coupling".

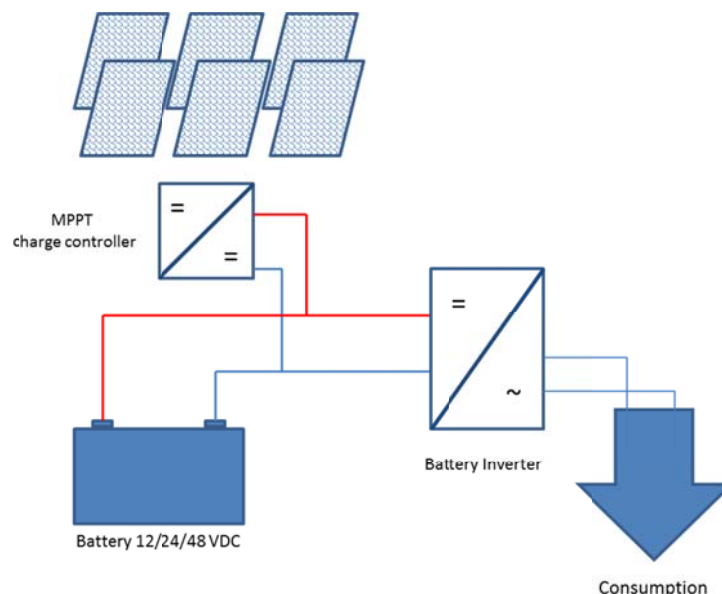

Figure 1: Typical system topology of a DC-coupled microgrid system

---

<sup>2</sup> UPS refers to Uninterruptable Power Supply

On the AC side, the Inverter-Charger acts as a voltage source that delivers the exact real-time energy consumption (apparent power). Depending on what system topology the user prefers to choose, solar energy can directly charge the batteries using MPPT charge controllers to ensure that the batteries can always recharge during the availability of sun irradiation. This is a conventional approach that has been followed by energy harvesters for several years. The disadvantage of DC-coupling is that the overall system efficiency is very low, and that the low voltage level leads to very high currents on the DC side – resulting in the requirement of expensive electrical components.

## 2.1 AC-coupling

A more up-to-date approach of integrating renewables like PV into MG systems is to use conventional grid-tie inverters feeding-in directly to the AC-side. This is possible because of the technological leap in continual development of inverters over the last years. Today's PV inverters and Inverter-Chargers are much smarter than those – from a couple of years ago. Features like frequency sweep to protect batteries from overcharging on the Inverter-Charger side, and the active and reactive power characteristic curves to keep the grid in balance on the grid-tie inverters have led this to a possibility.

Such a system topology is termed as “AC-coupled”. The efficiency in such a case of coupling is significantly higher, because the power produced from PV can be directly fed to the loads through the highly efficient PV inverters. Inverter-Charger serves to just bridge and link the gap. Any excess of solar energy can be additionally stored in the battery bank.

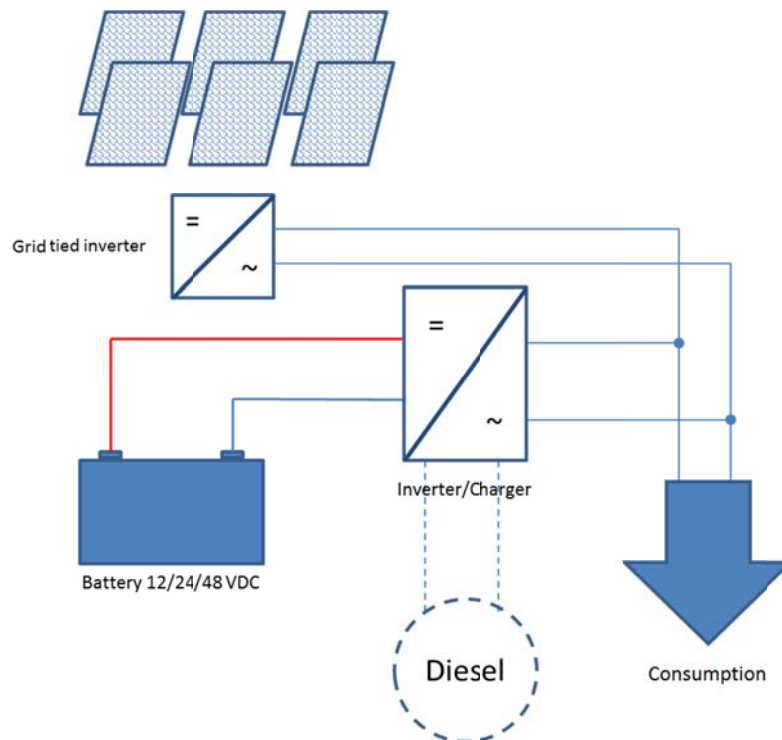

Figure 2: Typical schematic of an AC-coupled microgrid system

The main advantages of AC coupling include the following:

- / High system efficiency because of efficient components and less conversion losses in case direct power supply to the loads
- / Economical cost of components
- / Possibility of easy up-gradation of existing systems

### **2.1.1 Basic Inverter-Charger AC-coupling**

In remote regions that are deprived of access to electrical energy, battery inverters offer a simple solution to build MGs. Battery inverters when replaced by Inverter-Charger – renders other sources of energy to interact within the system. Additionally, diesel gensets can be used as a back-up option – in case of battery's State of Charge (SoC) drops, because of the lack of solar irradiation.

- / The basic rule valid for every Inverter-Charger driven MG application mentions that an installed PV power (i.e. max. AC Power) must not exceed the installed Inverter-Charger power. This ensures that the Inverter-Charger is not overloaded at any time. A strategy to increase the PV penetration in such systems is described in 2.1.3.
- / All Inverter-Charger units in parallel or three phase systems must be connected to the same battery

### **2.1.2 AC-coupling as grid back-up**

It is not necessary to connect the entire electrical installation to the Inverter-Charger while employing it as an AC-back-up. For such a case, it should be sufficient to define some critical loads that are required in an event of outage. In such cases, the installed capacity of Inverter-Charger can even be lower than that of a stand-alone case. Nevertheless, if the grid-tie inverter should also be on-line in a back-up case, it can be installed on the AC-out terminals of the Inverter-Charger.

### **2.1.3 Optimising microgrids / Extended Inverter-Charger AC-coupling**

As a matter of fact, batteries are the known and obvious cost drivers in an Inverter-Charger MG. To guarantee an un-interrupted supply of power, it becomes essential to have sufficient back-up of power capacity, and therefore, battery banks must not be undersized. By adding a quantum of intelligence into the system – it is possible to oversize the AC-coupled PV inverters with respect to the installed Inverter-Charger capacity (by monitoring the power fed into the battery). Therefore it needs a control that measures the load and controls PV power in a way that the maximum allowed power of charging the batteries through the Inverter-Charger is not exceeded at any time.

If most power demand is during the day-time (certain base load) it renders feasibility to cover most of the demand, supplied by PV (to reduce the battery charging losses), and also to ensure simultaneous charging of the batteries. This could lead to the decrease of the battery bank sizing, and in turn results the system to be cost effective. In case of reduced solar irradiation the Inverter-Charger nevertheless must be able to cover the peak load or small backup generators help out during these rare events. Also in case of poor irradiation that last for several days, a backup generator can prevent from the system from “run dry”.

.....

## 2.2 Fronius Microgrid Solution

The Fronius Microgrid Solution offers an AC-coupled system with the following listed advantages:

- / High system efficiency through the use of efficient system components and reduced conversion losses, in case of direct supply to the loads
- / Economical cost of components
- / Possibility of easy up-gradation of existing systems

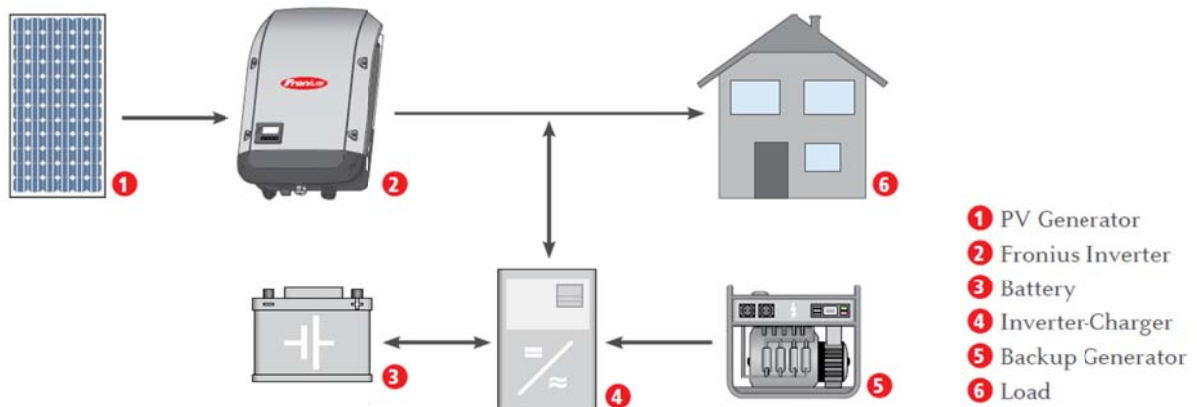

The Fronius inverter provides as much PV energy as possible to the Microgrid. Automatic PV power reduction is necessary in times where the load is lower than the possible PV production and the batteries are full (or when the charging power of the Inverter-Charger is too small).

Typically the power of the inverter is controlled without any communication. In this case the frequency droop of the Inverter-Charger and the frequency droop of the Fronius inverter cause optimal power setpoints.



/ Frequency droop function of Fronius inverters with MicroGrid setup.  
Fully adjustable to harmonise perfectly with the Inverter-Charger.

In addition to the frequency droop, a function for voltage dependent power reduction to prevent from over voltage caused tripping, and several reactive power control functions, can be activated and fully configured. There is also a possibility to implement load measurement to limit the maximum power that is to be consumed by the Inverter-Charger. This can be realised with using the Fronius PV-System Controller. With



these possibilities the size of the PV-system can be large in comparison to the size of the Inverter-charger for optimized systems.

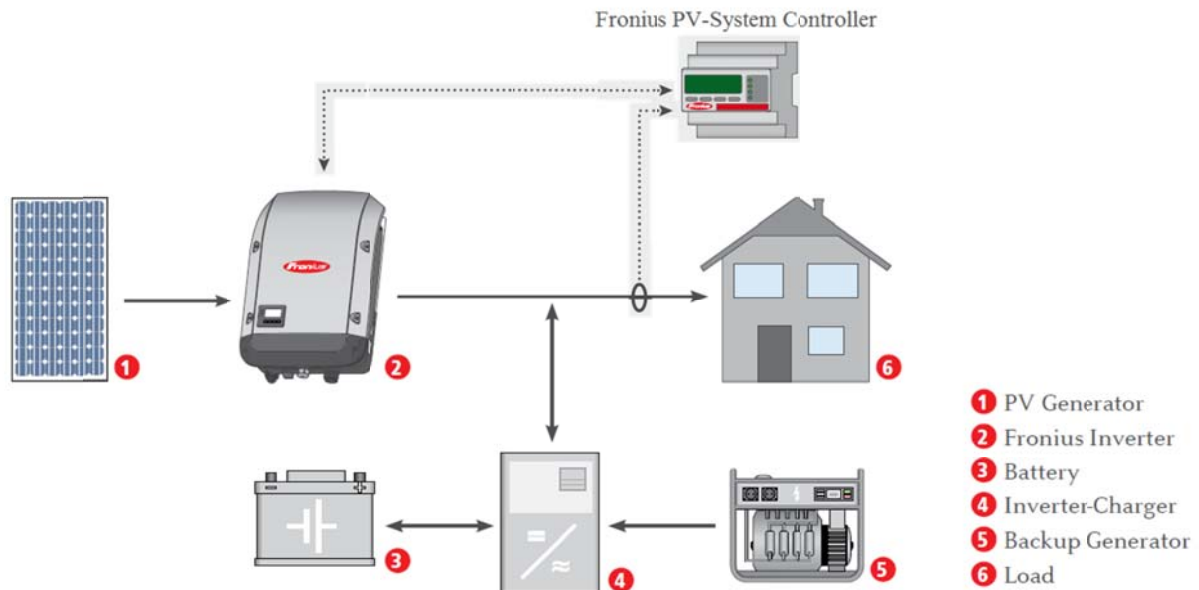

It is also possible to control the Fronius inverter via a 3<sup>rd</sup> party device. The available communication solutions are Modbus RTU or TCP (SunSpec Alliance Protocol) and/or Fronius Interface Protocol.

Furthermore, the protection settings in the Microgrid Setup are configurable. Whether the same settings for the Microgrid are also applicable for systems which are sometimes connected to the utility grid, depends on local connection rules.

The Fronius Microgrid Solution can be realized with all Fronius Inverters the Fronius PV-System Controller and Current Transducers.

Inverter-Charger products tested in combination with Fronius inverters:

- / Studer Xtender
- / Victron MultiPlus and Quattro

With these products the Fronius Microgrid Setup can be used without further configuration effort at the Fronius inverter. The standard settings work in correctly sized systems (The Inverter-Charger has to be configured according its manuals).

### 3 OPERATION OF PV-GENSET SYSTEMS

Diesel gensets and photovoltaic technology can be combined in perfect harmony. Although these technologies have rarely been in demand by the same users in the past, bringing the two generation systems together has now become extremely beneficial technically, ecologically and especially economically.

In remote areas or regions where the electricity supply is patchy or extremely expensive, grids powered by diesel gensets are an absolute must. The cost per kilowatt hour of electricity from a diesel genset is largely changeable, depending as it does on fuel and other variable costs. Only a small proportion is fixed. The costs can vary widely depending on country, transport distance and increasing oil costs on the global market (€0.05 – 2.5 per kWh).

The price trend in the photovoltaic sector is much more positive. Over the past few years the costs per kWh from PV systems have dropped dramatically around the globe (€0.07 - 0.14 per kWh).

For this reason there is a clear financial justification for integrating a Fronius PV-Genset solution into almost every diesel-powered system. Every unused diesel kWh saves money.

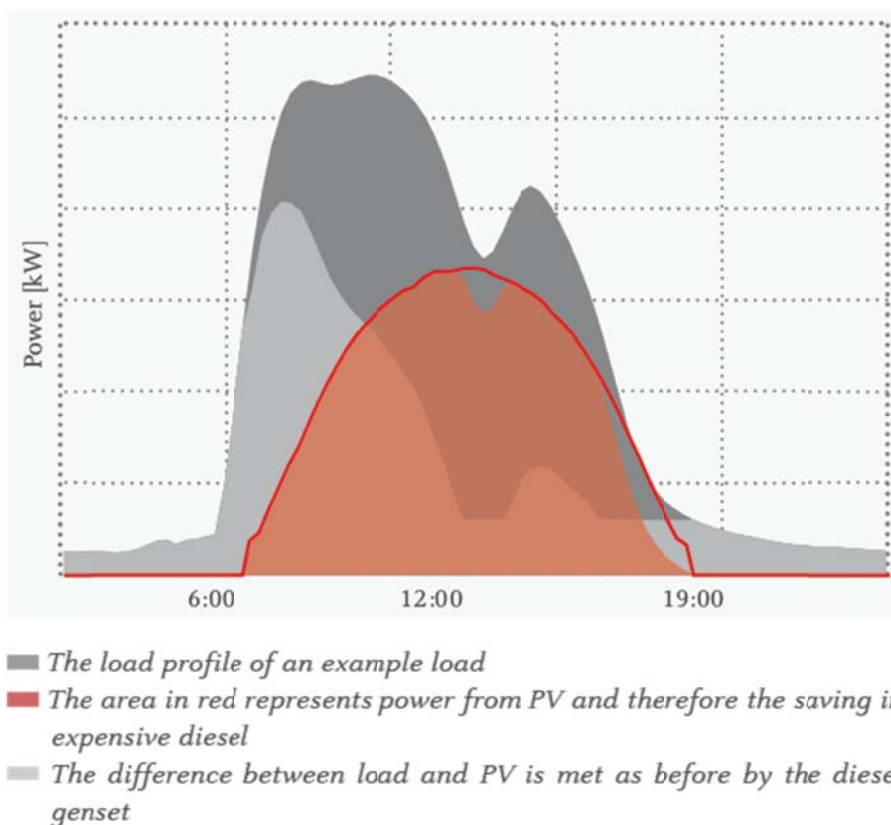

For any grid, and especially in case of MGs, the balance of power is mandatory for safe and stable operation. In large inter-connected grids, surplus spinning reserve and control mechanisms are considered to keep the system in balance (primary, secondary, and tertiary control).

In a MG system, conditions are mostly similar to the ones that are as mentioned above. A stable operation of a MG is of high significance. PV inverters are intended to not negatively impact the operation of genset systems. Power quality and reliability are therefore intended to improve, and if not, are at least intended to remain at the same level.

Various control algorithms that can be supported by PV inverters are further explained in this paper.

Gensets can be operated in isochronous or droop mode. Isochronous case of operation refers to the operation of generator at one constant frequency (similar to the inter-connected grids). Droop mode operation refers to the variation of frequency with respect to the load (i.e. open circuit frequency is higher than frequency at full load).

Firstly, active and reactive power generation and demand are required to be in balance. A mismatch in active power mainly leads to frequency deviation, and a mismatch in reactive power to a voltage deviation. In case, when two or more synchronous generators feed one load - the load sharing is typically implemented via either a droop load sharing or an isochronous load sharing.

Droop load sharing refers to the alteration of frequency with respect to the load such that the actual load remains supplied by all generators in the system, approximately at the same level.

Isochronous load sharing requires communication between gensets - either by means of an analog signal or digital communication (CAN, RS485 or Ethernet).

Using grid-tie inverters without special functionality<sup>3</sup> in MGs is - provided that the island detection is disabled – not a big issue, as long as inverter's power is very low (<10%) compared to the generator power and the load. In this case, the inverter's power is always consumed by the loads and that the actual grid source is slightly unburdened.

Increasing the installed PV power closer to the generator's power poses challenging aspects in terms of control. If PV power installed lies between 10 and 30% of generator's nominal power, an external device for controlling the inverter's output can be necessary. For increased PV power capacity (above 30 %) of generator's nominal power, an external control is necessary and also relevant information of consumption becomes essential. Otherwise the synchronous generator could get into operation modes that are disadvantageous for permanent operation or even dangerous in case of reverse power.

To participate in MGs with diesel gensets and significant PV penetration, it is important to control the inverter's output reliable and fast by means of a superior control device.

---

<sup>3</sup> "Normal" grid-tie inverter with unity power factor (PF = 1) and no additional characteristic curves

### 3.1 Fronius PV-Genset Solution

If the power from the photovoltaic system is proportionally quite large, the entire system must be optimally controlled to obtain the best possible diesel savings.

This is where the Fronius PV-System Controller comes into play. By using data from the Fronius inverters together with load measurements (as well as diesel genset measurements were necessary), the entire system can be monitored. This allows the Fronius inverters to be controlled. If several diesel gensets are in use, then these too have to be controlled at the same time. Further potential for optimisation exists where controllable (in terms of time) loads can also be taken into account.

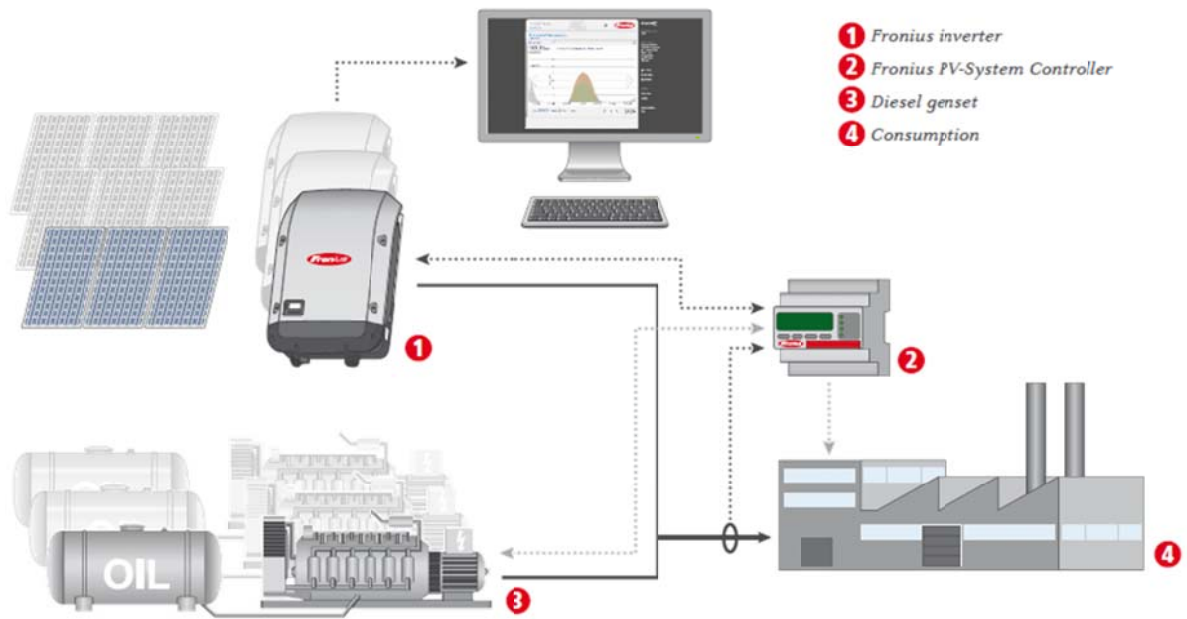

### 3.1.1 Protecting and optimizing the diesel genset

The diesel genset is a fundamental part of the system. Protecting it has to take the highest priority, as losing the generator would cause the entire power supply to fail.

The Fronius PV-System Controller assumes the following functions:

- / Ensuring that the minimum number of diesel gensets needed is in use during any given situation.
- / Checking that the diesel gensets are always being used in a manner that has the lowest possible impact on service life, even at low loads.
- / Guarantees an extremely quick and responsive control over the PV output. As a result, power fluctuations are compensated immediately and the strain on the diesel genset is reduced dramatically.

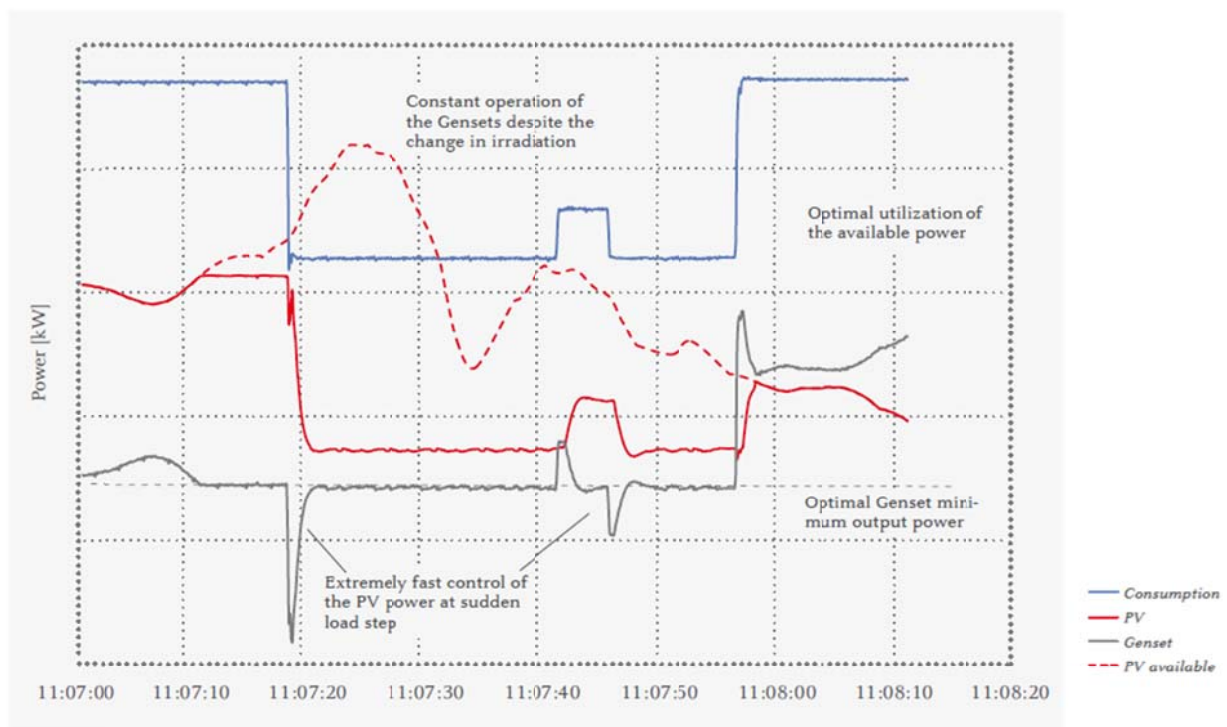

*/ Owing to the high level of dynamism exercised by the controller, the diesel genset can be operated under a steady load, thereby increasing service life and improving efficiency. Furthermore, this approach also enables the maximum diesel savings to be achieved.*

### 3.1.2 Optimising the PV-Genset system

It is very easy for a small PV system in relation to the load to pay for itself financially, but it does not represent a cost-effective form of optimisation. As the PV output never has to be restricted, the savings can simply be identified from the annual energy calculated in the respective region.

The difference between the costs of producing PV energy and the costs of producing electricity from diesel is normally quite large. The saving is therefore much higher if the size of the PV system has been designed so that temporary power restrictions are the norm. This significantly increases the amount of power supplied from photovoltaics. In order to identify the most cost-effective PV system size for each project, it is important

to examine the insolation and load profile alongside the variable diesel power costs and the cost of the PV system.

Simulations are then used to calculate the highest possible savings that could be achieved.

**Fronius can provide you with an unbeatable support in the planning of your PV-Genset system.**

### **3.1.3 Online system monitoring**

Every PV-Genset system can be designed, monitored, analysed and visualised at any time using the free Fronius Solar.web online portal. Up-to-date system data can be accessed at any time and is clearly presented: the portal is very user-friendly and easy to use, and a comprehensive range of analysis functions is included.

Fronius Solar.web is also available as an app to allow you to check your PV system data from your smartphone at your own convenience.

### **3.1.4 Products for the Fronius PV-Genset Solution**

All Fronius inverters can be used in a PV-Genset system. The Fronius PV-System Controller assumes all control functions over the system. Depending on the configuration, the required measuring accessories will also be offered.

Due to the open nature of Fronius communication solutions, it is also possible to implement individual solutions containing third-party components. With the Fronius Datamanager 2.0 or Fronius Datamanager Box 2.0, it is possible to incorporate all components into a control system using Modbus RTU or TCP with the SunSpec Inverter Control Model.

.....

## 4 APPENDIX: INVERTER FEATURES SUPPORTING MICROGRIDS

Regardless of the user's intention of designing an AC-coupled Inverter-Charger MG, or a PV-Genset application, modern Fronius PV-inverters come with a multi-featured functionality compared to the inverters of the past. Earlier, it was only necessary to feed-in with unity power factor ( $PF = 1$ ), but the capability of latest FRONIUS PV inverters extends far beyond that.

Key features to portray can include: Gradual Frequency dependent Power Reduction (GFdPR),  $P(f)$  or reactive power characteristics, viz.,  $\cos\Phi(P)$ ,  $Q(V)$  or  $Q(P)$  (also known as Frequency-Watt-curve, Watt-PF-curve, Volt-VAr-curve, Watt-VAr-curve.)

A control function, for e.g.  $P(V)$  (power limitation as a function of voltage; Volt-Watt-curve) prevents inverters from tripping due to overvoltage, and therefore, also plays an important role in MG applications.

Grid-tie inverters with reactive power functionality,  $P(f)$  and  $P(V)$  can be easily configured to be able to participate in MGs with positive influences.

### 4.1 Gradual Frequency dependent Power Reduction (GFdPR)

The most important control strategy in MGs is to be able to reduce the feed-in power according to the grid frequency. As most Inverter-Charger manufacturers use frequency sweep to protect batteries from being overcharged, GFdPR presents a key feature to prevent the system from becoming unstable. Therefore, Fronius inverters use a special  $P(f)$  function to reduce their power to zero, if the Inverter-Charger increases the value of frequency.

For e.g. at frequency value of 51 Hz inverter starts to reduce the power, and at 52.9 Hz the power feed is almost zero. The inverter further disconnects at a frequency value of 53 Hz.

Diesel gensets react on load steps by alteration of frequency until a new equilibrium is attained (1-5 s, depending on the load steps). A situation of PV power supply to the full load and excess feeds into the generator must be strictly avoided. GFdPR also has a positive effect after load rejection, due to its speed of reaction (<40ms).



*/ Frequency droop function of Fronius inverters with MicroGrid setup.  
Fully adjustable to harmonise perfectly with the Inverter-Charger.*

**Figure 3: Schematic depicting GFdPR strategy to ensure secure energy supply**

To top things off – individual parameters like bend frequency or reduction gradient are completely configurable, by means of a display to be able to meet the wide range of requirements of a MG, which need to be defined by the MG operator.

## 4.2 Gradual Voltage dependent Power Reduction (GVdPR)

Another strategy to stabilize power quality and security of energy supply is through GVdPR. If the value of voltage exceeds a defined threshold limit, power from the inverter reduces. This compensates the voltage rise caused by the inverter and thereby restricts the voltage to exceed the threshold limit that causes the disconnection of inverters.

The parameter set for GVdPR comprises of voltage threshold from where on the GVdPR is active, a static gradient (in %Pn/V) and two dynamic gradients (in %Pn/s) – one for attenuation and the other for return. These dynamic gradients are important parameters for voltage dips and swells.

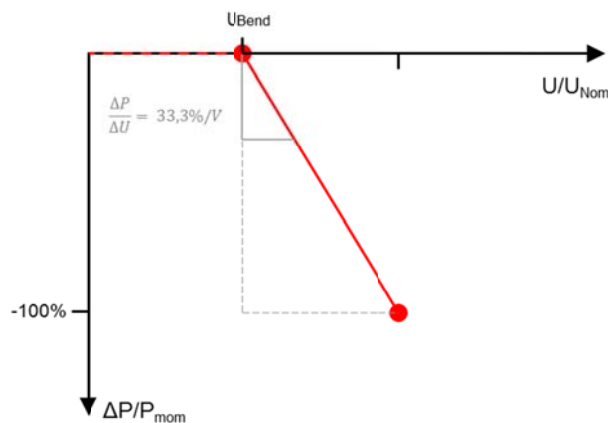
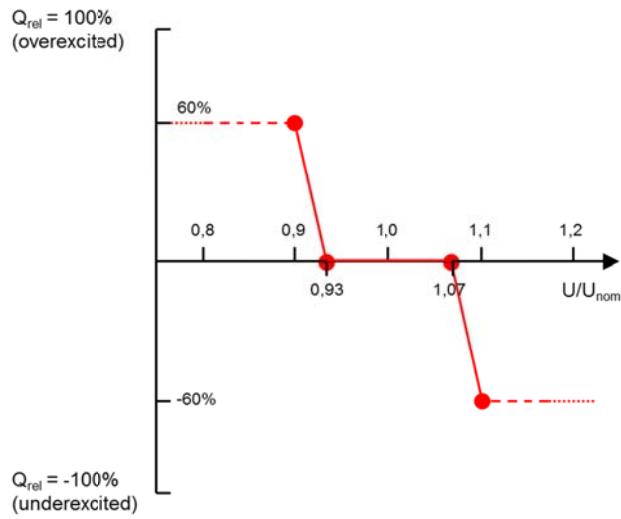

Figure 4: Schematic depicting GVdPR strategy to ensure secure energy supply

## 4.3 Reactive Power as a function of Voltage (Volt-VAR-curve)

Imbalance in reactive power also has an influence on power quality in MGs. Synchronous generators which act over-excited lead to rise of voltage at the terminals, and those that act under-excited lower the voltage at the terminals. To keep the reactive power in balance, Fronius-inverters also use a characteristic curve that is easily configurable – through the use of four set-points, if required. The Q(V) characteristic is characterized by an area around the nominal voltage, where reactive power is zero (called as “deadband”). Outside the deadband, reactive power follows a gradient to a certain reactive power limit. If this limit is attained, reactive power remains constant until the trip limits of inverter.





**Figure 5: Over-excitation & under-excitation of synchronous generators**

The mentioned Q(V) characteristic can be configured to be unsymmetrical and be adjusted to a certain situation in MGs. Also, the “deadband” can be set to a zero value.